

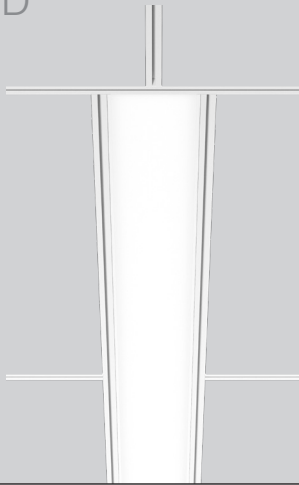

# LENO 4.0

## 24" GRID



### PERFORMANCE

- 120V / 277V Universal
- Up to 138lm/W
- CRI > 80 & CRI > 90
- Zero plenum lights
- Damp & Dry Rated

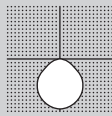

### 9/16" GRID

ARMSTRONG®  
SILHOUETTE®



ARMSTRONG®  
SUPRAFINE®



ARMSTRONG®  
INTERLUDE®



### 10 Business Days for all QuickShip items

- Maximum quantity: 400'
- "QuickShip" must be clearly listed on PO.
- QuickShip items must be on Separate Purchase Order.
- QuickShip orders must be received with complete and correct catalog numbers.
- Variant request will not qualify for QuickShip program.
- QuickShip orders must be received before 2 pm EST. After 2 pm, shipping will be based on the next business day.
- QuickShip orders are based on standard XAL terms for payment.
- Order change of any type will affect shipping times.
- Partial shipments may be required based on current factory inventory.



[link to page](#)



### Catalog Number Example

LENO-WP-OP-30K-C80-UNV-010V-0475LF-ST-4FT

#### A RANGE

QS LENO 4.0 L E N O

#### B CEILING SYSTEM

QS Armstrong 9/16" Grid \*

\*compatible with Armstrong 9/16" grid only

#### C WHIP / THROUGH-WIRE

QS Whip 6' W P

#### D LENS

QS HP opal cover O P

#### E CCT

QS 3000K 3 0 K

QS 3500K 3 5 K

#### F CRI

QS CRI > 80 C 8 0

QS CRI > 90 C 9 0

#### G VOLTAGE

QS 120V / 277V U N V

#### H DIMMING

QS 0-10V 1% 0 1 0 V

#### I OUTPUT LM/FT DIRECT

QS 475lm/ft 0 4 7 5 L F

QS 695lm/ft 0 6 9 5 L F

QS 905lm/ft 0 9 0 5 L F

#### J CIRCUIT / EM

QS Single circuit \*

#### K SHAPE / PATTERN

QS Linear / straight S T

#### L DIMENSIONS IN FT



QS 4' fixture 4 F T

QS 8' fixture 8 F T

QS Custom length X X F T

(QS in 4' increments only)

**Technical data**

	SIZE TYPE	LED COLOR TEMPERATURE	INPUT WATTS	DELIVERED LM TOTAL	LIGHT DISTRIBUTION	DELIVERED LUMEN DIRECT	OPTICAL EFFICIENCY	LUMINAIRE EFFICACY
<b>LENO 4.0 24" GRID whip</b>								
	4' opal	35K	15 W	1940 lm		1940 lm		138 lm/W
	8' opal		29 W	3880 lm		3880 lm		138 lm/W
	4' opal	35K	22 W	2840 lm		2840 lm		134 lm/W
	8' opal		44 W	5680 lm		5680 lm		134 lm/W
	4' opal	35K	30 W	3700 lm		3700 lm		130 lm/W
	8' opal		59 W	7400 lm		7400 lm		130 lm/W

for 30K or 35K multiply lm value by 0.96

**Accessories**

**LENO RELEASE TOOL** CODE  
LENO releasing tool for Armstrong grid ceilings LENO R00700

**HURRICANE BRACKET** CODE  
For ceiling requiring two separate mounting points LENO H00000

**ARMSTRONG CONNECTOR BRACKET** CODE  
Armstrong lighting connector bracket (LCB4) visit armstrong.com  
please contact your Armstrong rep

**WHIP FIXTURE**

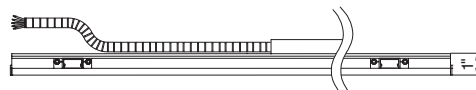

**Dimensions**

LENO 4.0 24" GRID / 4.0 30" GRID



Armstrong® Silhouette®  
XL 1/16" bolt slot grid



Armstrong® Suprafine®  
XL 1/16" flat T-grid



Armstrong®  
Interlude® XL HRC

**Grid ceiling**

XAL LENO is only approved for Armstrong® 1/16" Suprafine®, Silhouette®, Interlude®, AXIOM® cove, drywall and TechZone® ceiling systems.

Armstrong® lighting connector brackets make installation quick and easy with no independent suspension required. The brackets must be installed at every LENO location along the ACT ceiling (see drawings in the technical data section).

Approved for seismic D, E, F installations.



DIMENSIONS

Four installation types

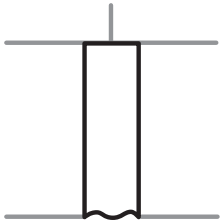

on-center

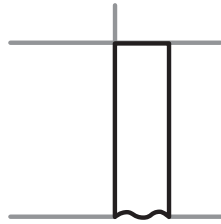

offset

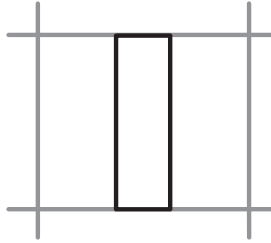

middle

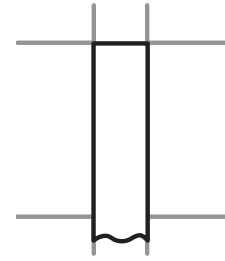

4" TechZone

ARMSTRONG® Ceilings Integration

ACT ceiling

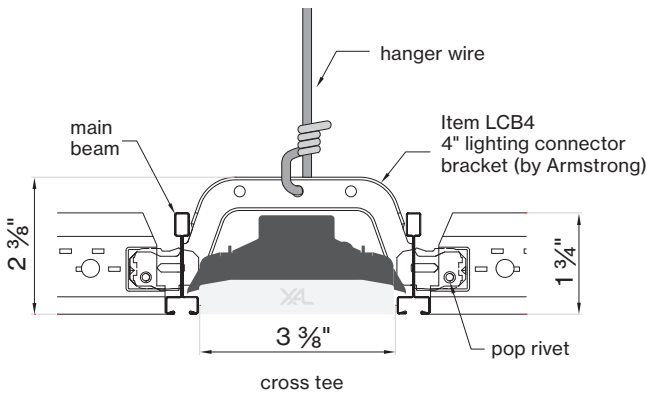

Lighting connector bracket position

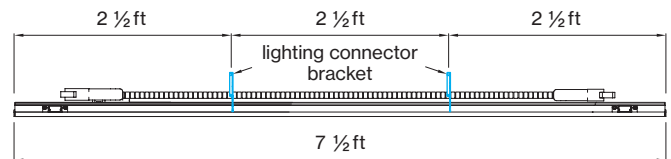
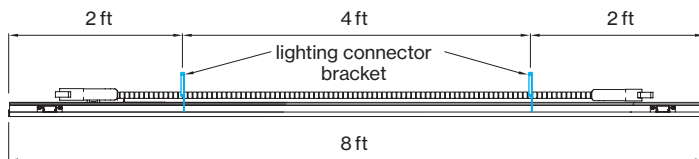
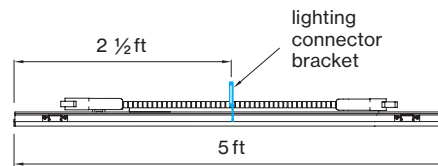
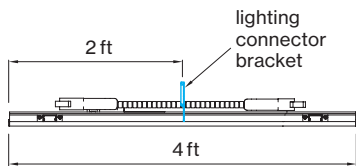

LENO mounting instructions

Get access to LENO mounting instructions faster by scanning the QR code.



[www.xalusa.com/resources/mounting-instructions/leno](http://www.xalusa.com/resources/mounting-instructions/leno)